



Food Processor Cutter mixer 3.6 lt s/s bowl

ITEM # _____

MODEL # _____

NAME # _____

SIS # _____

AIA # _____



602224 (DKSS36PVSAU) Cutter mixer 3.6 lt with stainless steel bowl, sealed lid, variable speed 500-3600 rpm, Australia

Short Form Specification

Item No. _____

Table top cutter mixer. 3,6 litres, stainless steel bowl with sealed lid, scraper and central feed hole for adding products in mid-cycle. Transparent copolyester lid. Microtoothed blade rotor. Angled blades and conical base of the bowl ensure consistent mixing. All ingredients are processed evenly and quickly thanks to a special flow generated inside the bowl. No-volt release system prevents accidental start of the appliance. All parts in contact with food are removable and Dishwasher safe. Waterproof, easy to clean, flat, soft-touch buttons. Variable speed with 9 levels (500 to 3600 rpm) for extra smooth results and emulsifying.

Main Features

- Tabletop cutter mixer and emulsifier allowing fast chopping, mixing, mincing, griding, liquidizing and kneading.
- Includes 3,6 liter stainless steel bowl with micro-toothed blades rotor.
- Bowl/lid scraper included for uniform smooth results (emulsifying) and continuous working.
- Transparent lid, with funnel shaped hole, to add ingredients during use.
- All ingredients are processed evenly and quickly thanks to a special movement generated inside the bowl.
- Easy to clean and waterproof control panel with flat on/off button and pulse function.
- Pulse function for coarse chopping.
- All parts in contact with food are removable without the use of tools, completely dismountable and dishwasher safe.
- Productivity up to 50 settings per service.
- 9 speed levels for extra smooth results and high speed emulsifying.

Construction

- Food safety assured in accordance to European directives and UK legislation. In addition, materials in contact with food, are BPA-free.
- Product safety conform to European directives, UK legislation and international health and safety standards.
- Variable speed: 500 - 3600 rpm.
- Motor power: 750 Watt.
- Bowl in AISI 304 stainless steel.
- Micro-toothed blades in 420 AISI stainless steel and ergonomic scraper in resistant composite material to ensure consistent mixing.
- compact design, easy to move and store.
- IPX5 (IP55) waterproof, flat, touch-control panel.
- Main switch ON/OFF on the back of the appliance.
- Asynchronous industrial motor with no brushes for high reliability and quiet functioning, stainless steel motor shaft.

APPROVAL: _____



Food Processor Cutter mixer 3.6 lt s/s bowl

Included Accessories

- 1 of MICROTOOTHED BLADE ROTOR FOR 3.6LT CUTTER MIXER PNC 650233
- 1 of STAINLESS STEEL BOWL FOR 3.6LT CUTTER MIXER PNC 650235
- 1 of TRANSPARENT LID FOR 3.6LT CUTTER MIXER BOWL WITH SEALING AND SCRAPER PNC 653862

Optional Accessories

- TRANSPARENT LID FOR 2,6LT CUTTER MIXER BOWL PNC 650117
- TRANSPARENT LID (WITHOUT SEALING) FOR 3,6LT CUTTER MIXER BOWL PNC 650118
- MICROTOOTHED BLADE ROTOR FOR 2.6LT CUTTER MIXER PNC 650226
- SMOOTH BLADE ROTOR FOR 2.6LT CUTTER MIXER PNC 650227
- STAINLESS STEEL BOWL FOR 2,6 LT CUTTER MIXER PNC 650228
- TRANSPARENT COPOLYESTER BOWL FOR 2,6 LT CUTTER MIXER PNC 650229
- SCRAPER FOR 2.6LT CUTTER MIXER BOWL PNC 650230
- STAINLESS STEEL BOWL FOR 2,6LT CUTTER MIXER, MICROTOOTHED ROTOR, LID WITH SCRAPER PNC 650231
- MICROTOOTHED BLADE ROTOR FOR 3.6LT CUTTER MIXER PNC 650233
- SMOOTH BLADE ROTOR FOR 3.6LT CUTTER MIXER PNC 650234
- STAINLESS STEEL BOWL FOR 3.6LT CUTTER MIXER PNC 650235
- SCRAPER FOR 3.6LT CUTTER BOWL PNC 650236
- TRANSPARENT BOWL FOR 2,6LT CUTTER MIXER, MICROTOOTHED ROTOR, LID WITH SCRAPER PNC 650245



Food Processor
Cutter mixer 3.6 lt s/s bowl

The company reserves the right to make modifications to the products without prior notice. All information correct at time of printing.

2026.06.16

Front

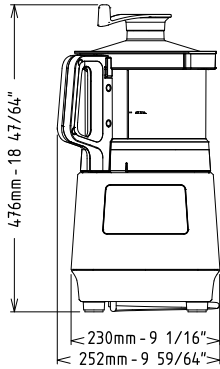

Side

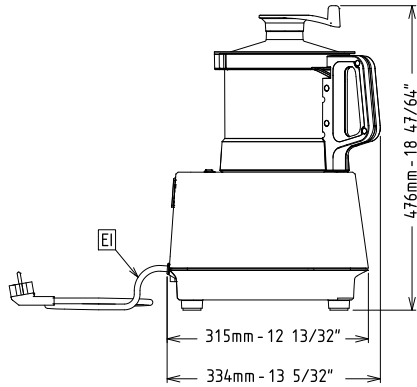

EI = Electrical inlet (power)

Top

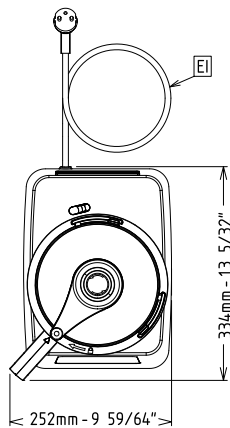

Electric

Supply voltage:	220-240 V/1N ph/50/60 Hz
Electrical power max.:	0.75 kW
Total Watts:	0.75 kW

Capacity:

Performance (up to):	0 kg/Cycle
Capacity:	3.6 litres

Key Information:

External dimensions, Width:	252 mm
External dimensions, Depth:	334 mm
External dimensions, Height:	476 mm
Shipping weight:	19 kg
Net weight (kg):	14.4
Cold water paste:	
Egg whites:	